

### RESET PUSHBUTTON

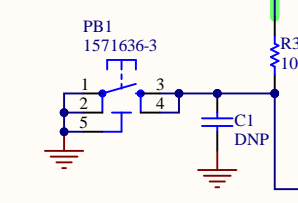

### USB



### I2C PULLUPS NOT MOUNTED

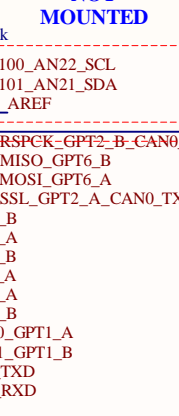

### USB CONNECTOR

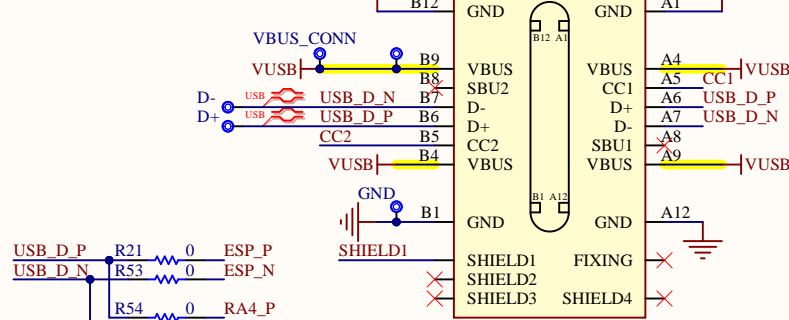

### LED MATRIX

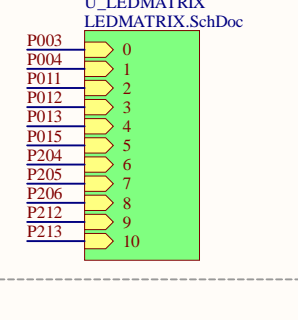

### DC JACK

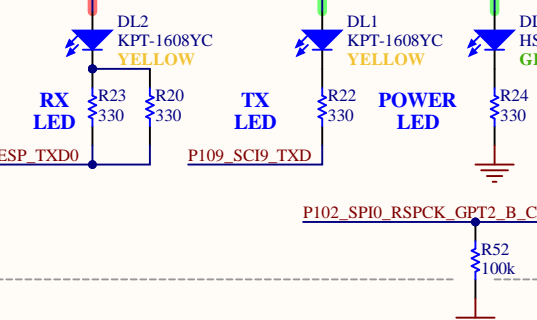

### BUCK CONVERTER

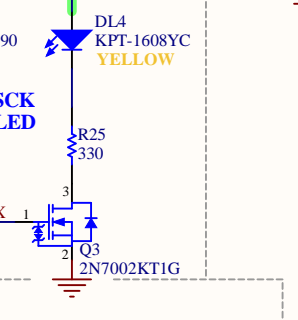

### ESP HEADERS

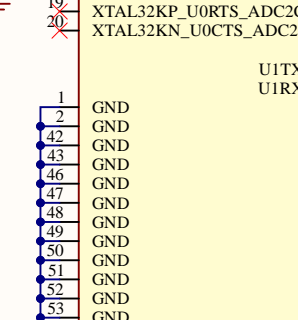

### 3V3 LINEAR REGULATOR

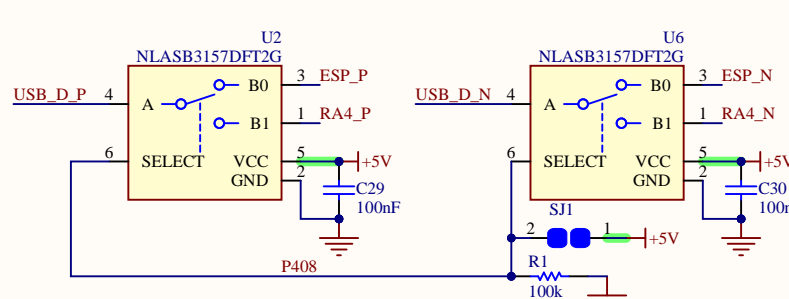

### ESD PROTECTION

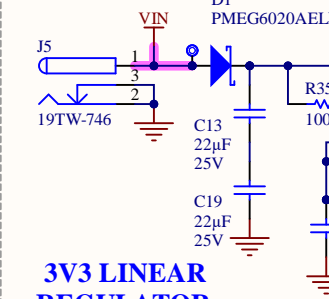

### CC RESISTORS

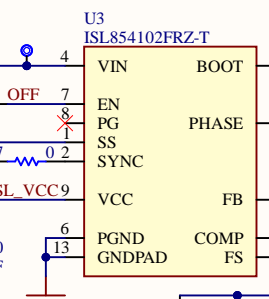

### SHIELD1

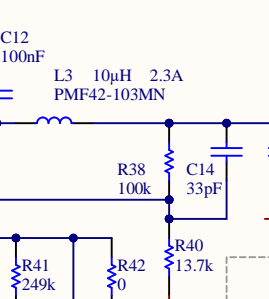

### LEVEL TRANSLATOR

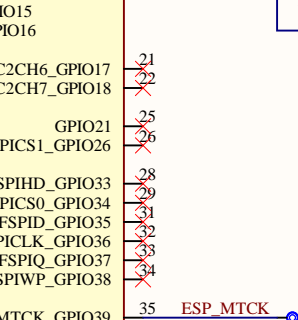

Reference Designs ARE PROVIDED "AS IS" AND "WITH ALL FAULTS. Arduino SA DISCLAIMS ALL OTHER WARRANTIES, EXPRESS OR IMPLIED, REGARDING PRODUCTS, INCLUDING BUT NOT LIMITED TO, ANY IMPLIED WARRANTIES OF MERCHANTABILITY OR FITNESS FOR A PARTICULAR PURPOSE.  
 Arduino SA may make changes to specifications and product descriptions at any time, without notice. The Customer must not rely on the absence or characteristics of any features or instructions marked "reserved" or "undefined".  
 Arduino SA reserves these for future definition and shall have no responsibility whatsoever for conflicts or incompatibilities arising from future changes to them. The product information on the Web Site or Materials is subject to change without notice.  
 Do not finalize a design with this info. ARDUINO and other Arduino brands and logos and Trademarks of Arduino SA. All Arduino SA Trademarks cannot be used without owner's formal permission.

<b>Title: UNO R4 WiFi</b>					
ID: ABX00087		Version: V0.3			
Date: 6/19/2023	Time: 2:42:31 PM	Sheet 1 of 2			
File: TOP.SchDoc	Author: Silvio Navaretti	RevAuthor: Silvio Navaretti			

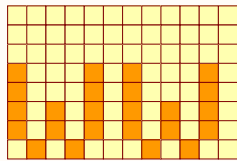

1	2	3	4	5	6	7	8	9	10	11	12
13	14	15	16	17	18	19	20	21	22	23	24
25	26	27	28	29	30	31	32	33	34	35	36
37	38	39	40	41	42	43	44	45	46	47	48
49	50	51	52	53	54	55	56	57	58	59	60
61	62	63	64	65	66	67	68	69	70	71	72
73	74	75	76	77	78	79	80	81	82	83	84
85	86	87	88	89	90	91	92	93	94	95	96

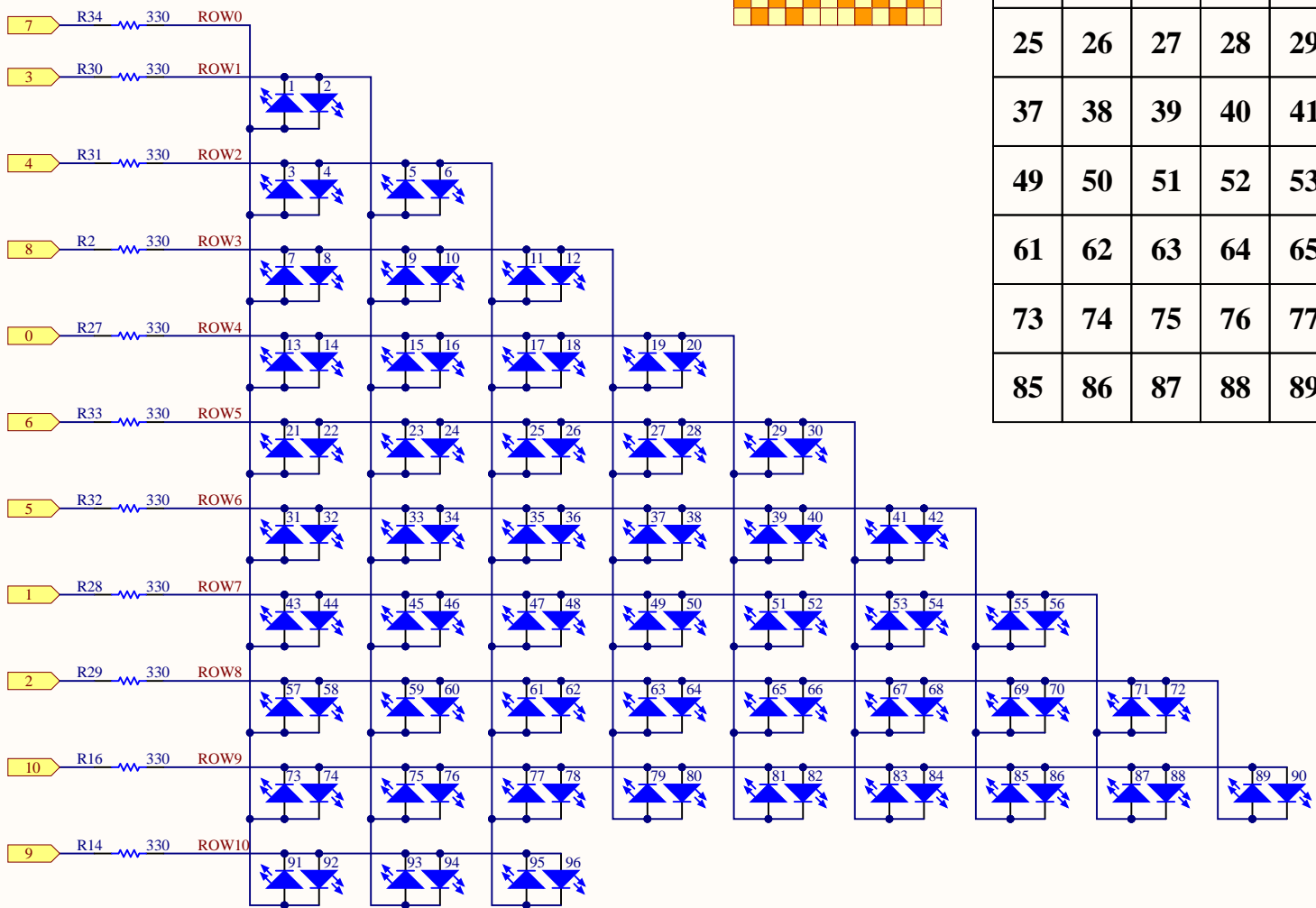

Reference Designs ARE PROVIDED "AS IS" AND "WITH ALL FAULTS". Arduino SA DISCLAIMS ALL OTHER WARRANTIES, EXPRESS OR IMPLIED, REGARDING PRODUCTS, INCLUDING BUT NOT LIMITED TO, ANY IMPLIED WARRANTIES OF MERCHANTABILITY OR FITNESS FOR A PARTICULAR PURPOSE. Arduino SA may make changes to specifications and product descriptions at any time, without notice. The Customer must not rely on the absence or characteristics of any features or instructions marked "reserved" or "undefined". Arduino SA reserves these for future definition and shall have no responsibility whatsoever for conflicts or incompatibilities arising from future changes to them. The product information on the Web Site or Materials is subject to change without notice. Do not finalize a design with this info. ARDUINO and other Arduino brands and logos and Trademarks of Arduino SA. All Arduino SA Trademarks cannot be used without owner's formal permission.

<b>Title: LED MATRIX</b>				
ID: ABX00087		Version: V0.3		
Date: 6/19/2023 Time: 2:42:36 PM		Sheet 2 of 2		
File: LEDMATRIX.SchDoc		Author: Silvio Navaretti		RevAuthor: Silvio Navaretti